







# 4meter combined pole install Instruction

	lightning rod ① 1pc	plastic plug ② 2pcs	bullet camera bracket ③ 1pc	PTZ camera bracket ④ 1pc	top pole ⑤ 1pc	extension pole ⑥ 1pc	turning part ⑦ 1pc	lock nut ⑧ 1pc	base pole ⑨ 1pc
<b>Accessories</b>									
			<b>optional</b>						

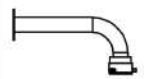
1

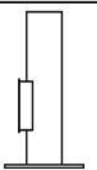
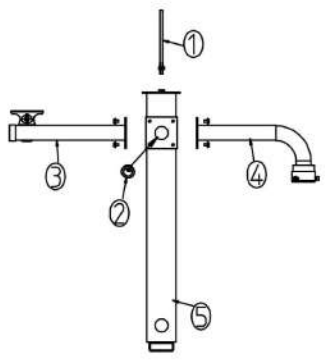

Install PTZ bracket and bullet bracket onto any 2 directions on the top pole, and seal other 2 directions not using with plastic plugs. Install the lightning rod on the top

2

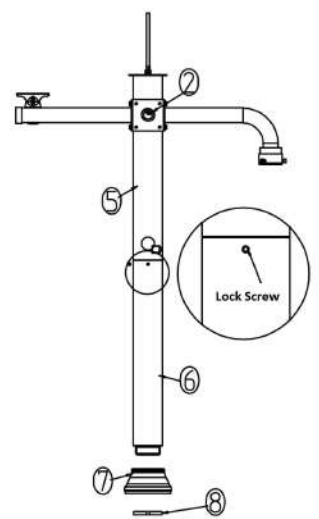

Assembly the top pole and extension pole, tight the lock screw on the extension pole after assembly. Install the lock nut and turning part at the bottom of extension pole

3

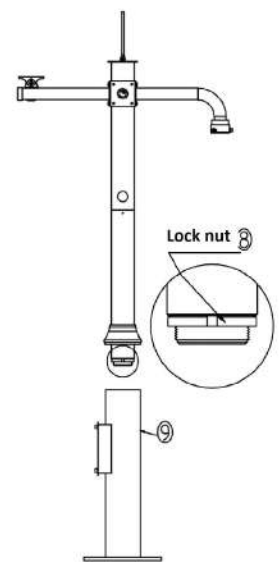

Assembly the extension pole onto base pole, tight the lock nut



# Assemble Cage Installation Instruction

1

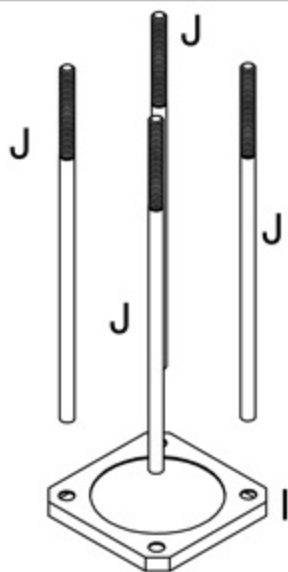

1. put the steel reinforcement into steel plate holes

2



2. Use M16 nuts tighten steel reinforcement

3

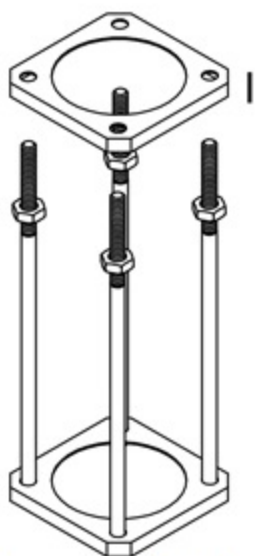

3. Let the steel plate cover steel reinforcement

4

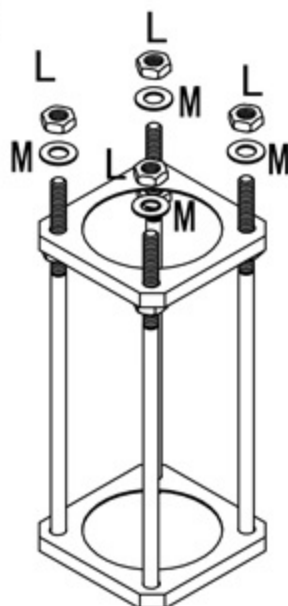

4. Use M16 nuts and back-up plates twists in steel reinforcement

Product accessories

I



steel plate  
2pcs

J



steel  
reinforcement  
4pcs

M



back-up plate  
8pcs

L



M16 nuts  
8pcs

