



Ruijie RG-EST310 Series Wireless Bridges

Hardware Installation and Reference Guide 1.00

Copyright statement

Ruijie Networks©2020

Ruijie Networks reserves all copyrights of this document. Any reproduction, excerption, backup, modification, transmission, translation or commercial use of this document or any portion of this document, in any form or by any means, without the prior written consent of Ruijie Networks is prohibited.

Exemption statement

This document is provided “as is”. The contents of this document are subject to change without any notice. Please obtain the latest information through the Ruijie Networks website. Ruijie Networks endeavors to ensure content accuracy and will not shoulder any responsibility for losses and damages caused due to content omissions, inaccuracies or errors.

Preface

Thank you for using our products. This manual will guide you through the installation of the device.

Scope

It is intended for the users who have some experience in installing and maintaining network hardware. At the same time, it is assumed that the users are already familiar with the related terms and concepts.

Obtaining Technical Assistance

Ruijie Networks Website: <https://www.ruijienetworks.com/>

Technical Support Website: <https://ruijienetworks.com/support>

Case Portal: <https://caseportal.ruijienetworks.com>

Community: <https://community.ruijienetworks.com>

Technical Support Email: service_rj@ruijienetworks.com

Skype: [service_rj@ruijienetworks.com](https://www.ruijienetworks.com)

Related Documents

Documents	Description
Configuration Guide	Describes network protocols and related mechanisms that supported by the product, with configuration examples.
Command Reference	Describes the related configuration commands, including command modes, parameter descriptions, usage guides, and related examples.

Documentation Conventions

The symbols used in this document are described as below:

 This symbol brings your attention to some helpful suggestions and references.

 This symbol means that you must be extremely careful not to do some things that may damage the device or cause data loss.

1 Product Overview

RG-EST310 is an 802.11ac wireless bridge designed for video postback scenario. Its 5GHz radio delivers an access rate of 867Mbps.

The IP68 design adapts to inclement outdoor environments such as the cold and humidity. This substantially simplifies installation and maintenance.

1.1 Technical Specifications

Table 1-1 RG-EST310 Technical Specifications

Model	RG-EST310
Chip	QCA9886
Memory/Flash	512M bits/64M bit
RF Design	Single-Band Dual-Stream 2x2
Transmission Protocol	802.11ac
Bands	802.11a/n/ac: 5G (Country-Specific)
Antenna	Directional antenna, Horizontal 60°, Vertical 30°
Bridging Distance	1km
Spatial Streams	2
Max Throughput	5GHz: 867Mbps
Modulation	OFDM: BPSK@6/9Mbps, QPSK@12/18Mbps, 16-QAM@24Mbps, 64-QAM@48/54Mbps OFDM: BPSK, QPSK, 16QAM, 64QAM, 254QAM
Receive Sensitivity	11a: -89dBm (6Mbps), -80dBm (24Mbps), -76dBm (36Mbps), -71dBm (54Mbps) 11n: -83dBm@MCS0, -65dBm@MCS7, -83dBm@MCS8, 65dBm@MCS15 11ac: -86dBm@MCS0, -63dBm@MCS9
Transmit Power	≤250mw (24dBm) (adjustable)
Adjustable Power	1dBm
Dimensions (W x D x H)	147 mm ×76 mm×37 mm (without brackets, 0.48 in. x 0.25 in. x 0.12 in.)
Weight	0.35 kg
Fixed Port	One 10/100Base-T Ethernet port, supporting 24 V PoE
Button	One Reset Button
Status LED	One system status LED, one LAN status LED and three RSSI LEDs
Power Supply	24 V PoE (24 V PoE adapter) or 12 VDC
Power Consumption	< 5W
Temperature	Working Temperature:-30°C to 65°C (-22°F to 149°F) Storage Temperature: -40°C to 70°C (-40°F to 158°F)
Humidity	Working Humidity: 5% to 95% (non-condensing) Storage Humidity: 5% to 95% (non-condensing)
Mounting	Wall/pole mounting
Protection Class	IP65

Flammability	V0
UV Protection	F1
Safety Compliance	GB4943 EN/IEC 60950-1
EMC	GB9254 EN301 489
Health	EN 62311
Radio Frequency Certification	China Radio Transmission Equipment Type Approval Certificate EN300 328 EN301 893

1.2 LED & Button

Table 1-2 LED

LED	State	Meaning
System Status	Solid green	Video recorder mode
	Fast blinking green	The system is being upgraded or reset.
	Blinking green at a frequency of 2Hz	Camera mode
LAN Port Status	Solid on	The LAN port is not receiving or transmitting data.
	Blinking	The LAN port is receiving or transmitting data.
RSSI (3 LEDs in total)	LED 1 blinks	RSSI < -69dBm
	LED 1 is solid on.	-69dBm < RSSI < -59dBm
	LED 1 and LED 2 are solid on.	RSSI > -59dBm
	LED 1, LED 2 and LED 3 are solid on.	RSSI > -49dBm
	Off	No signal

Table 1-3 Button

Button	Function	Operation
Reset	Reboot	Press the button for 2 seconds, and the device will be rebooted.
	Reset	Press the button for over 5 seconds until the LED starts to blink. Release the button, and the device will be reset.

1.3 Product Image

RG-EST310 provides a LAN port (RJ-45 port) and a 12 VDC port.

Figure 1-1 Top View of RG-EST310



Figure 1-2 Bottom View of RG-EST310



Ports

Figure 1-3 Ports



Note 1. 12 VDC Port

2. 10/100Base-T Ethernet Port (PoE-capable)

3. Reset

Power Supply

RG-EST310 adopts 24 V PoE or 12 VDC power supply (standard accessory: 24 V/0.5A PoE adapter).

Note Please do not use a PoE adapter or switch of another model. The device may be damaged.

2 Preparing for Installation

 To prevent device damage and physical injury, please read the safety recommendations carefully as described in this chapter.

 Suggestions do not cover all possible hazardous situations.

2.1 Lightning Protection

- When the connection cable between the main grounding conductor and local equipotential earthing terminal board (LEB) on each floor is shorter than 2 meters, use a stranded copper wire with a sectional area not less than 1.318 mm² (16 AWG) for the connection cable.
- Use a shielded network cable if possible, ensure that devices connected to both ends of the shielded network cable are reliably grounded, and make sure that the sheath of the shielded network cable is also grounded if possible. If no shielded network cable is available, wire the network cable through a steel pipe and bury the steel pipe for lead-in, and properly ground both ends of the steel pipe.
- No additional lightning protector is required as a high-profile lightning protector is built in the RG-EST310 and the antenna port and power port support 4kV lightning protection. If a lightning protector of a higher profile is available, configure the lightning protector optionally. Before the configuration, connect the lightning protector to the ground cable.

2.2 Installation Site

- Do not expose the device to high temperature, dust, or harmful gases.
- Do not install the device in an area prone to fire or explosions.
- Keep the device away from EMI sources such as large radar stations, radio stations, and substations.
- Do not subject the device to unstable voltage, vibration, and noises.
- Keep the device at least 500 meters away from the ocean and do not face it towards the sea breeze.
- The installation site should be protected from water and flooding, seepage, dripping, or condensation.
- The installation site should be selected according to network planning, communications equipment features and considerations such as climate, hydrology, geology, earthquake, electric power, and transportation.

2.2.1 Temperature and Humidity

To ensure the normal operation and equipment service life, maintain appropriate temperature and humidity levels in the equipment room. See Table 2-1.

Table 2-1 Temperature and Humidity Requirement

Working Temperature	-30°C to 65°C (-22°F to 149°F)
Working Humidity	5% to 95% (non-condensing)

2.2.2 Outdoor Installation

RG-EST310 supports wall mounting and pole mounting.

2.2.3 EMI

Various interference sources, from either outside or inside the device or application system, affect the system in the conductive ways such as capacitive coupling, inductive coupling, and electromagnetic radiation. There are two types of electromagnetic interferences: radiated interference and conducted interference, depending on the type of the propagation path. When the energy, often RF energy, from a component arrives at a sensitive component via the space, the energy is known as radiated interference. The interference source can be either a part of the interfered system or a completely electrically isolated unit. Conducted interference results from the electromagnetic wire or signal cable connection between the source and the sensor. Interference along the cable the interference is transmitted from one unit to another. Conducted interference often affects the power supply of the device, but can be controlled by a filter. Radiated interference may affect any signal path in the device, and is difficult to shield.

- Effective measures should be taken for the power system to prevent electric grid interference.
- The working ground of the routers should be properly separated and kept as far as possible from the grounding device of the power device or the anti-lightning grounding device.
- Keep the device away from high-power radio transmitter, radar transmitting station, and high-frequency large-current device.
- Take electrostatic shielding measures.

2.3 Installation Tool

Table 2-2 Installation Tools

Tools	Marker, Phillips (crosshead) screwdriver, slotted screwdriver, drill, paper knife, crimping pliers, diagonal pliers, wire stripper, network cable tester, related power and fiber cables, wrench, hammer, cable ties, ESD tools, multimeter
-------	---

 The tool kit is not shipped with RG-EST310. You need to prepare a tool kit.

2.4 Unpacking and Checking

Please check your goods carefully against the parts list. If you have any questions or there are any errors, please contact your distributor.

3 Installing the Device

⚠ Before installing the device, make sure you have carefully read the requirements described in Chapter 2.

3.1 Installation Flowchart

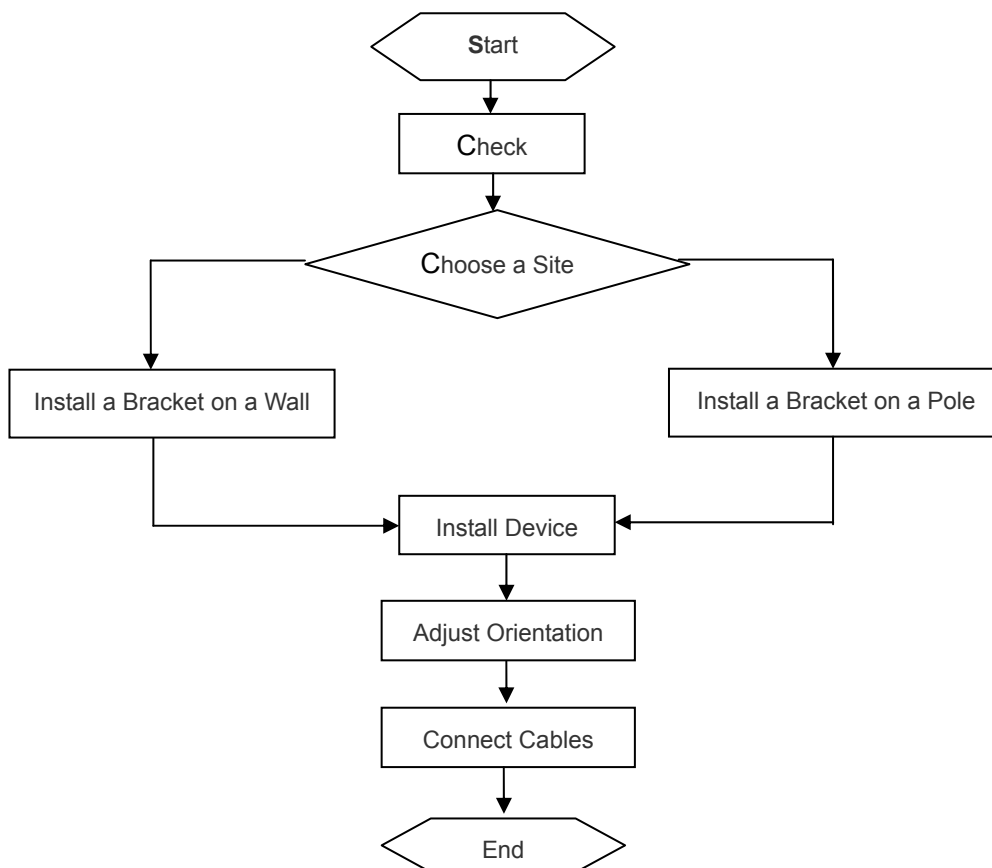

3.2 Before You Begin

Before you install the device, verify that all the parts in the parts list are there and make sure that:

- The installation site meets temperature and humidity requirements.
- The installation site is equipped with a proper power supply.
- Network cables are in place.

3.3 Precautions

The device can be mounted on a wall and a pole (diameter: 35 mm to 89 mm). If the diameter of the pole is out of the range, the hose clamp is customer-supplied. In this case, we strongly recommend you to use a hose clamp with thickness of 2.5mm at least. Otherwise, the device could fall down and cause injuries. The installation site can vary due to on-the-spot surveys conducted by technical personnel.

Please make full preparations as described in Chapter 2 and observe the following precautions before installing the device.

- Before connecting the power supply, please use the PoE adapter shipped with the device or use a PoE adapter with the same specification.
- Before connecting the power cord, make sure the power switch is in the OFF position.
- Make sure the power supply is properly connected.

3.4 Installing Device

Figure 3-1 Wall Mounting

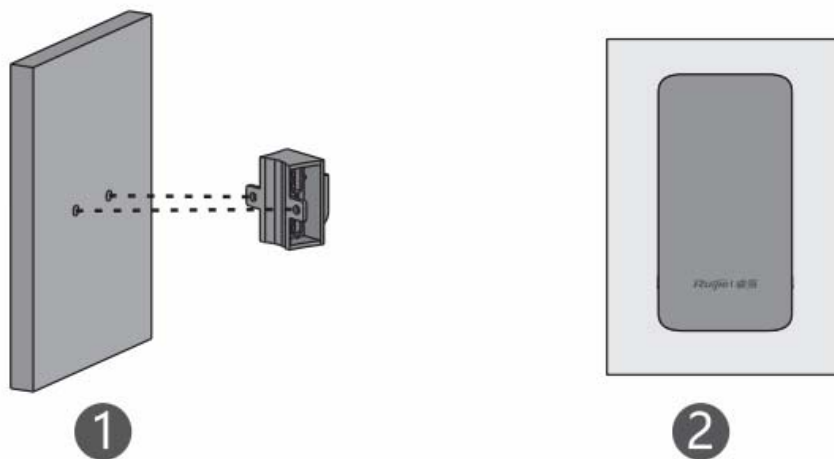

1. Secure the mounting bracket on the wall.
2. Install the device to the mounting bracket.

Figure 3-2 Pole Mounting

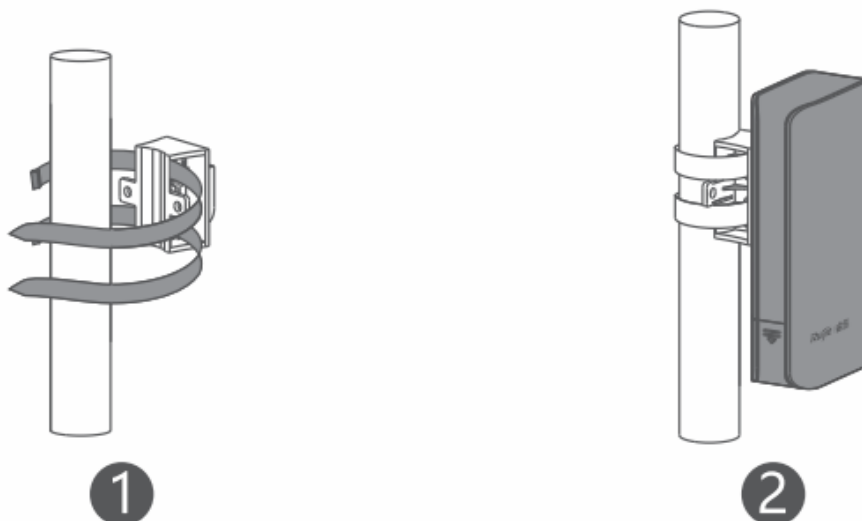

1. Secure the mounting bracket to the pole by threading two clamps through the mounting bracket.
2. Install the device to the mounting bracket.

3.5 Connecting Cables

1. Select a cable according to the distance between the wireless bridge and the PSE.
2. Plug one end of the cable into the PoE port of the PoE injector and plug the other end into the LAN port of the device. Connect the LAN port of the PoE injector to the server or camera. Connect the PoE adapter to the DC port of the PoE injector. Or you can connect the PoE adapter to the DC port of the device. Plug one end of the cable to the LAN port of the device and plug the other end to the server or camera.

Figure 3-3 Video Recorder End

Cable Connection

Video Recorder End

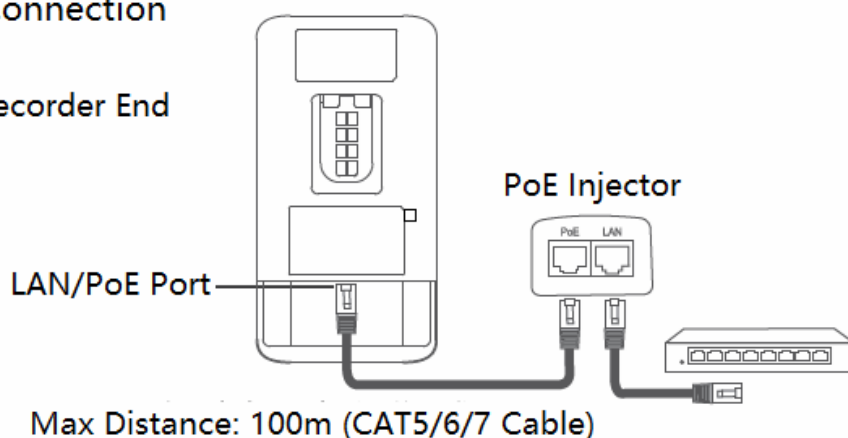
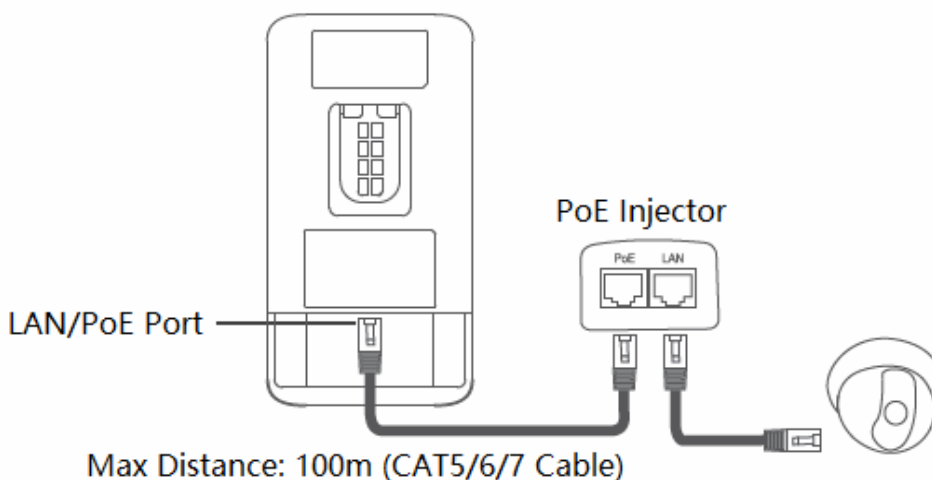



Figure 3-4 Camera End

Camera End



-  Please install the rear cover for waterproof and dustproof purpose.
-  Please do not use a PoE adapter or switch of another model. The device may be damaged.

Appendix A Connectors and Media

1000BASE-T/100BASE-TX/10BASE-T

The 1000BASE-T/100BASE-TX/10BASE-T is a 10/100/1000 Mbps auto-negotiation port that supports auto MDI/MDIX.

Compliant with IEEE 802.3ab, 1000BASE-T requires Category 5e 100-ohm UTP or STP (STP is recommended) with a maximum distance of 100 meters (328 feet).

1000BASE-T requires all four pairs of wires be connected for data transmission, as shown in Figure A-1.

Figure A-1 1000BASE-T Connection

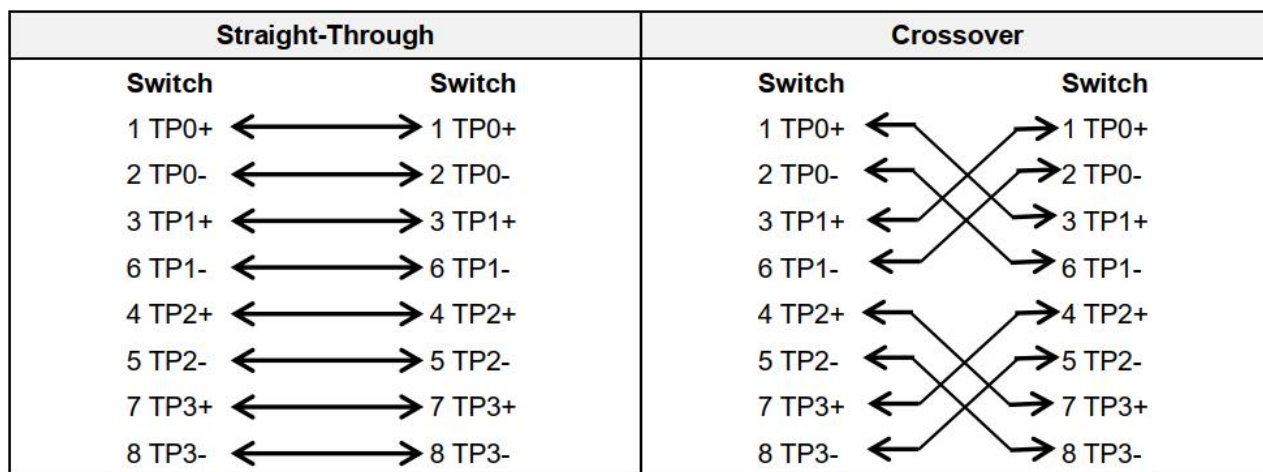

10BASE-T uses Category 3, 4, 5 100-ohm UTP/STP and 1000BASE-T uses Category 5 100-ohm UTP/STP for connections. Both support a maximum length of 100 meters. Table A-1 shows 100BASE-TX/10BASE-T pin assignments.

Table A-2 100BASE-TX/10BASE-T Pin Assignments

Pin	Socket	Plug
1	Input Receive Data+	Output Transmit Data+
2	Input Receive Data-	Output Transmit Data-
3	Output Transmit Data+	Input Receive Data+
6	Output Transmit Data-	Input Receive Data-
4,5,7,8	Not used	Not used

Figure A-3 shows wiring of straight-through and crossover cables for 100BASE-TX/10BASE-T.

Figure A-3 100BASE-TX/10BASE-T Connection

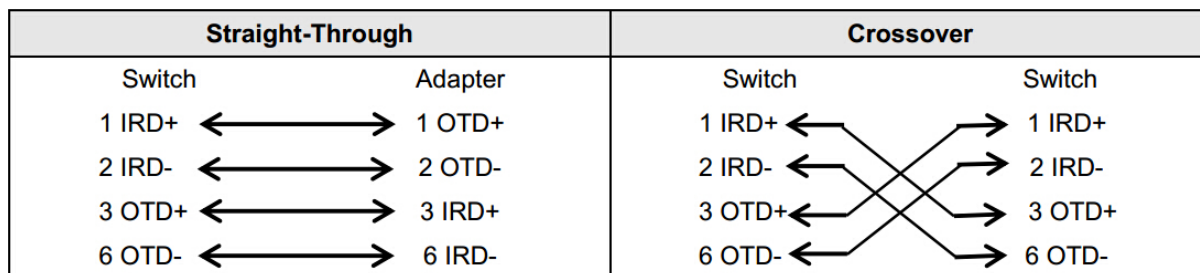

Appendix B Parts List

Table B-1 RG-EST310 Parts List

No.	Item	QTY	Remark
1	RG-EST310 Camera End	1	
2	RG-EST310 Video Recorder End	1	
3	24V/0.6A Power Adaptor	2	
4	Ruijie RG-EST310 Series Wireless Bridges Hardware Installation Guide and Reference Guide	1	
5	Self-Tapping Screws	4	
6	Screw Anchors	4	
7	Hose Clamp	4	
8	Bracket	2	